

## ***CS-687 Pneumatic Flat Cool + Heat Press Machine***

### **Operation Manual**

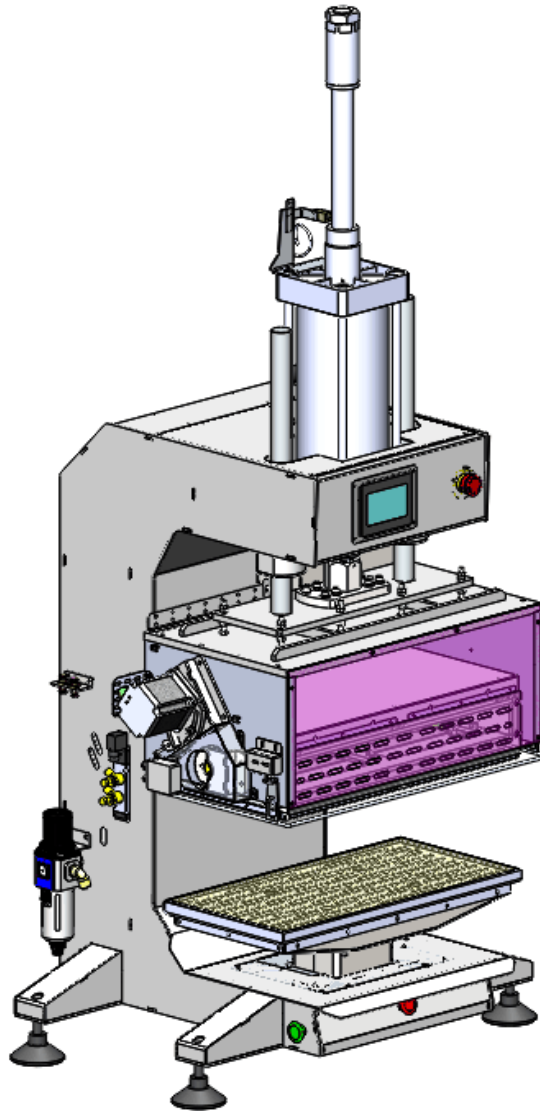

is powered by

**H&H Asia Group Limited**

e = [service@hh.com.hk](mailto:service@hh.com.hk)  
t = 852.24813068  
f = 852.24813727

Room 1117, 11/F, Asia Trade Centre, 79 Lei Muk Road, Kwai Chung, N.T., Hong Kong.

## Content

> Precautions with regard to Safety .....	3
> Name Plate .....	5
> Introduction .....	6
> Specifications .....	7
> Features .....	8
> Component Names .....	9
> Preparation for Installation .....	10
> Operation and Controls .....	11
>> Touch Screen Control .....	11
>> Main page .....	11
>> Heating time span setting .....	14
>> Mode .....	15
>> Pressure .....	15
>> Program version .....	16
>> Language Selection .....	16
>> Supervisor Mode Selection .....	17
>> Alarm Handling .....	17
>> Temperature Monitoring Setting .....	19
>> Pressure Monitoring Setting .....	20
>> IO Monitor .....	21
>> Calibration .....	21
>> Statistics .....	23
>> Test mode .....	24
>> Preferences .....	25
>> Trend .....	26
>> Manual Control Console .....	27
>> Press Pressure Adjustment .....	27
> Precaution when Using Mold .....	28

---

>> Correct .....	28
>> Incorrect.....	28
> Cleaning and Maintenance .....	29
>> Cleaning the Thermo Plates.....	29
>> Daily Maintenance .....	29
>> Monthly Maintenance .....	29
> Trouble Shooting.....	30
> Appendix A . Pneumatic Scheme .....	31
> Appendix B . Wiring Scheme .....	32

> Precautions with regard to Safety

Please observe these safety tips for safe, efficient, an injury-free operation of your equipment. By strictly following all instruction contained in this manual you will certainly obtain an excellent performance from the use of this equipment for many years.

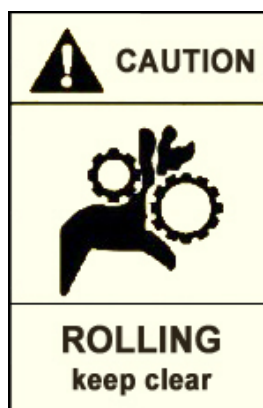

> Precautions with regard to Safety (cont.)

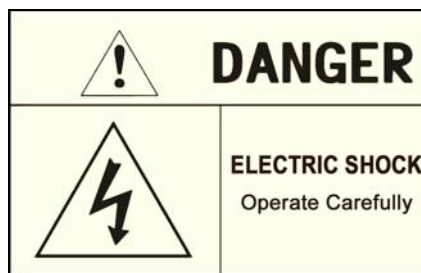
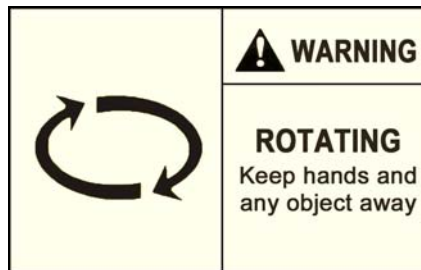

> Name Plate

<b>Model : CS-687</b>				
<b>Pneumatic Flat Cool + Heat Press Machine</b>				
<b>spec v-F2A1-060030</b>				
<b>Voltage</b>	<b>Frequency</b>	<b>Power</b>	<b>Compressed Air</b>	<b>Weight</b>
220 V	50/60 Hz	3600 W	>0.4 Mpa	400 Kg
<b>Date :</b>			<b>S/N :</b>	

**H&H Asia Group Ltd.**  
Room 1117, 11/F, Asia Trade Centre, 79 Lei Muk Road, Kwai Chung, N.T., Hong Kong  
Tel : (852) 2481-3068 Fax : (852) 2481-3727  
[www.hh.com.hk](http://www.hh.com.hk)  
MADE IN CHINA



## > **Introduction**

Thank you for your choosing of CS-687 which is manufactured by H&H.

This manual is aimed for the operators to understand the machine and avoid damage to the machine or personnel. Please read this manual carefully and keep it well for daily reference usage.

**> Specifications**

Model	:	CS-687
Voltage	:	220 V, Single Phase
Frequency	:	50/60 Hz
Power Consumption	:	3600 W
Compressed Air	:	>0.4 Mpa
Heat Temperature Range	:	30~260°C
Heat Press Duration	:	1~999 second
Heat Press Size	:	610mm x 310mm (length x with)
Lower Platform Size	:	610mm x 308mm (length x with)
Overall Dimensions	:	935mm x 695mm x 1988mm (length x with x height)
Overall Weight	:	400 kg

Note : due to continuous improvement, specifications are subjected to change without prior notification



**> Features**

- Control system – user friendly touch screen interface.
- Safety protection –safety lever around the main working area. The machine will stop when this lever frame is lifted. Both of the start buttons must press simultaneously (within 0.5 second), otherwise the machine will not activate. The press need to reach the bottom working platform for 0.5 second before the hand can release the start buttons. The safe device mode enable for “any key cancel” can cancel the press down motion with any button.
- Individual heat temperature control.
- Individual heat cycle timing setting control.

> **Component Names**

>> **View**

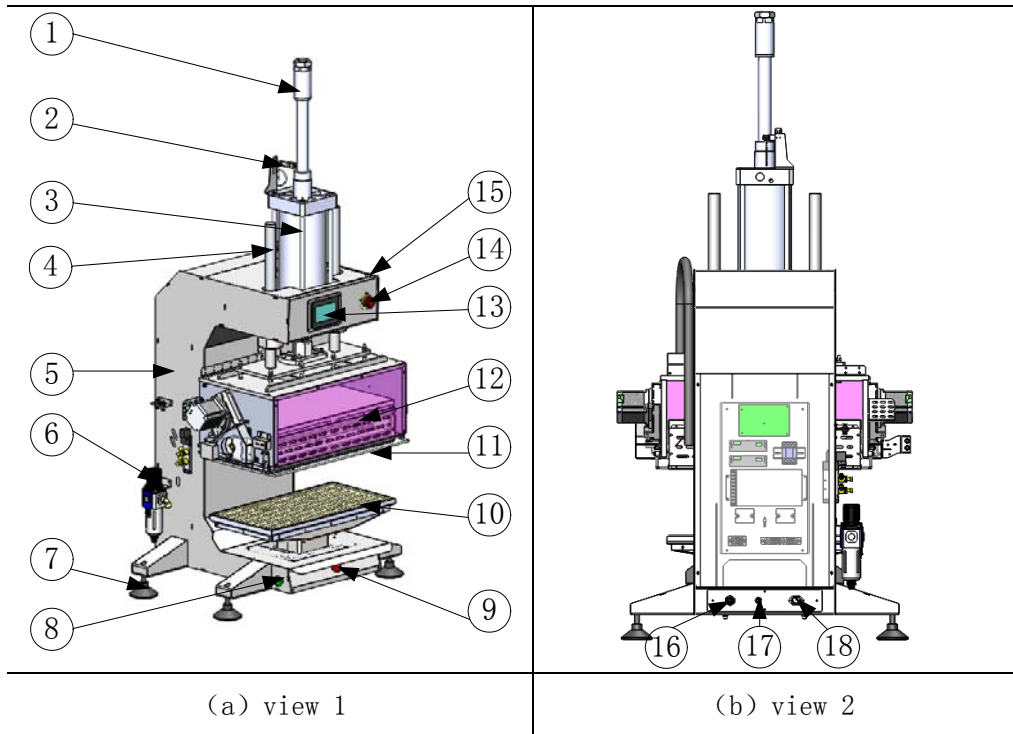

Machine parts name

1. press pressure adjusting knob	10. lower working table (platform)
2. position sensor	11. safety bar
3. press cylinder	12. safety cover (press plate inside)
4. guide bars	13. touch screen control panel
5. frame	14. emergency stop switch
6. compress air filter & regulator	15. operator/supervisor control key switch
7. the adjustable feet	16. power cable inlet
8. start button left(work in pair)	17. foot pedal (optional) connecting socket
9. stop/cancel button	18. connection of vacuum

**> Preparation for Installation**

Installation must be carried out by authorized personnel. Please act according to the following steps :

1. Remove the package of the machine and placed it on the ground level, cleaning the machine before operation.
2. Unleashing all packing cables which tie to the machine and allow it from free movement.
3. Connect air hose to the inlet of the air regulating filter at the back of the machine, make sure the air pressure not lower than 0.4Mpa. Once connected, the heat plate will go up.
4. You can connect the foot pedal (optional) power plug with the corresponding socket at the back.
5. Connect the power cord with a 220V, 22A power supply.
6. Switch on the power switch (emergency stop switch) at the right top of the machine.
7. The touch screen panel will on and showing the program loading page. After a while, it will change to show the main control page.

> **Operation and Controls**

>> **Touch Screen Control**

The 1<sup>st</sup> & 2<sup>rd</sup> pages are welcome note & program loading pages. It will show up once the machine is powered on.

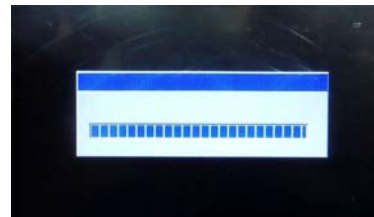

>> **Main page**

The 3<sup>rd</sup> page of the panel is named "main" means it is the main control of the machine.

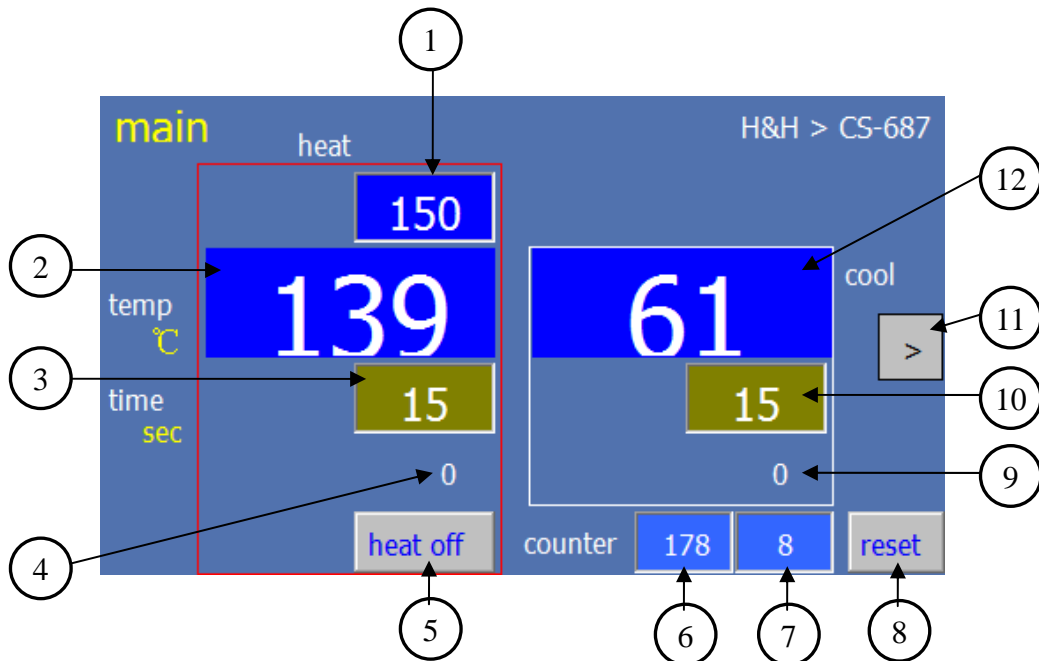

1. heating temperature preset button & display.
2. heating plate online temperature feedback
3. heat press time preset button & display.
4. heating time duration count down.
5. heating on/off button (when heater is on, the text will turn red and the arrow at left will display).
6. press down counter (can be reset by #8 button).
7. times of action cancel or safety bar triggered, cannot reset by operator.
8. reset button (for press down counter #6)
9. cooling time duration count down.
10. cool press time preset button & display.
11. next page button.
12. cooling temperature preset button & display.

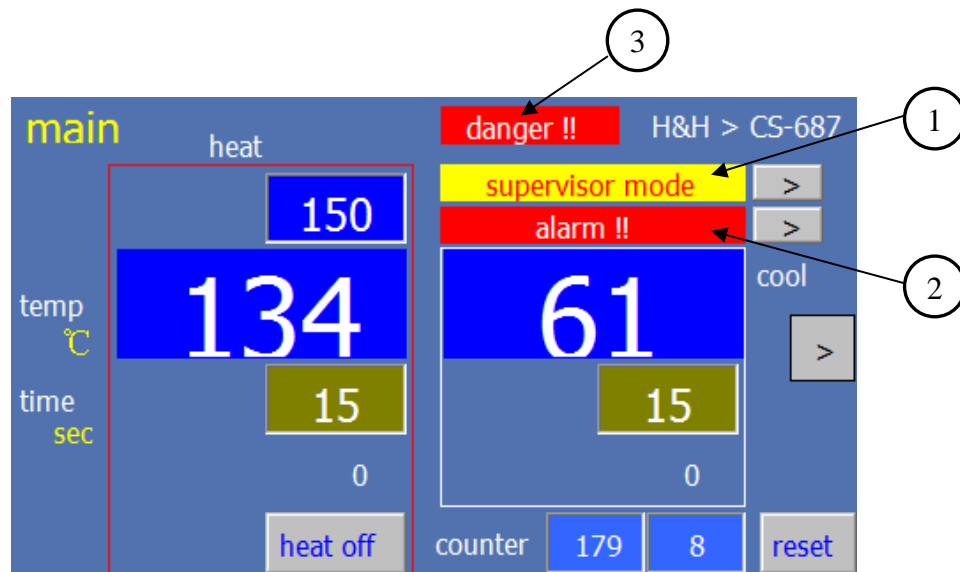
> **Operation and Controls (cont.)**>> **Main page (cont.)**

1. When the control key is turned right, the main page will show up a yellow banner "supervisor mode".
2. An alarm will display when there is/are any fault or beyond the parameter setting range.
3. When the foot pedal is enable or auto cool cycle is enable the main page will display danger.

## >> Heating Control

At the main page, you can preset the temperature setting at the panel.

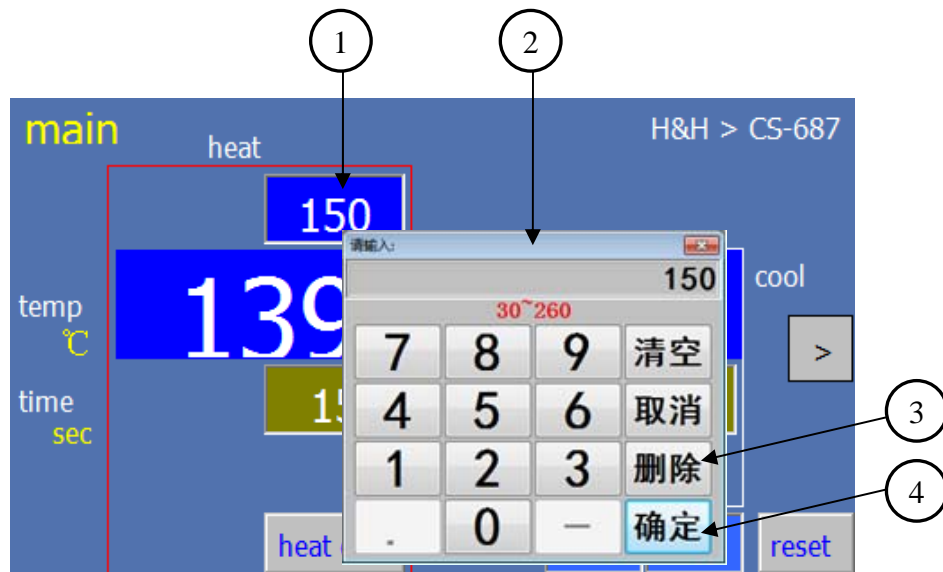

1. heating temperature preset button & display
2. input key pad
3. cancel
4. input accept

Press button #1 can preset the requesting heating temperature. The key pad #2 for heat temperature setting will pop up. You can enter the heating setting via this interface (input range 30~260 °C) and confirm with the button #4 “ok” or if the original default setting is satisfied. Press button #3 “cancel” if there is no need to change.

## > Operation and Controls (cont.)

### >> Heating time span setting

At the main page, you can set the press time span at the panel.

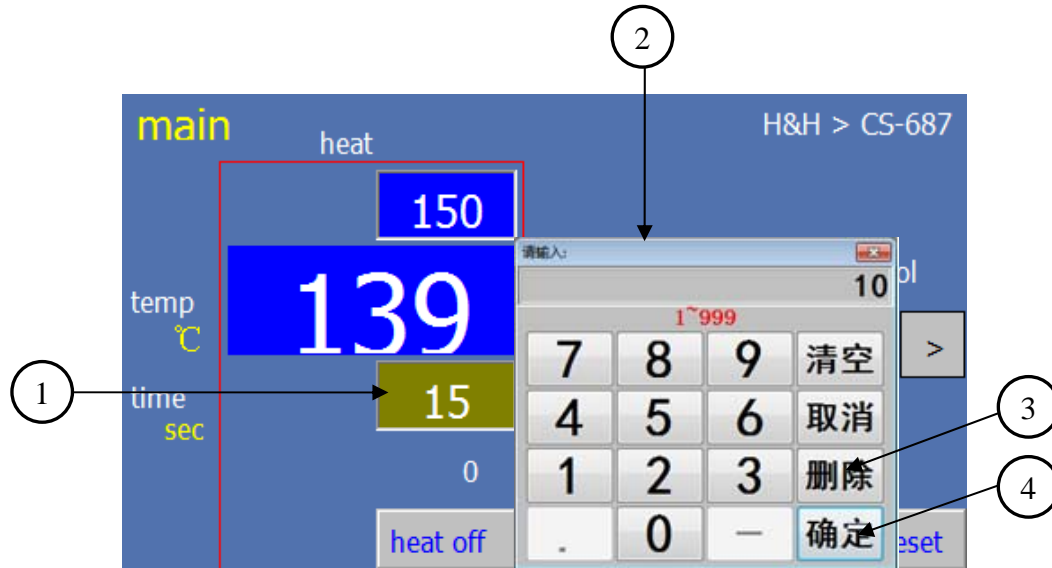

1. heating press time setting button & display
2. input key pad
3. cancel
4. input accept

Press button #1 can preset the requesting heating press time. The key pad #2 for heating press time setting will pop up. You can enter the heating press time via this interface (input range 1~999 second) and confirm with the button #4 "ok" or if the original default setting is satisfied. Press button #3 "cancel" if there is no need to change.

Cooling press time can be set similar to heating press time.

> **Operation and Controls (cont.)**

>> **Mode**

The next page after “main” page is “mode” page.

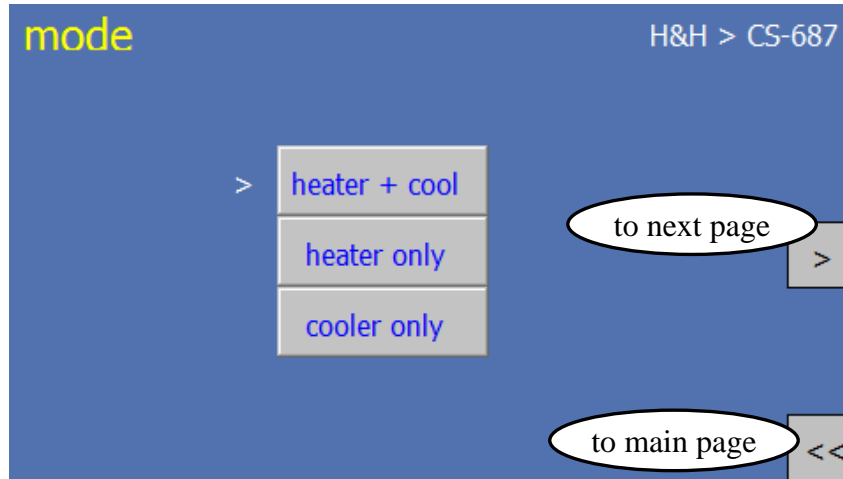

You can choice work mode for the device, including heater + cool, heater only and cooler only. When you choice heater + cool, the press plate will goes to cool plate automatically.

>> **Pressure**

The next page after “mode” page is “pressure” page.

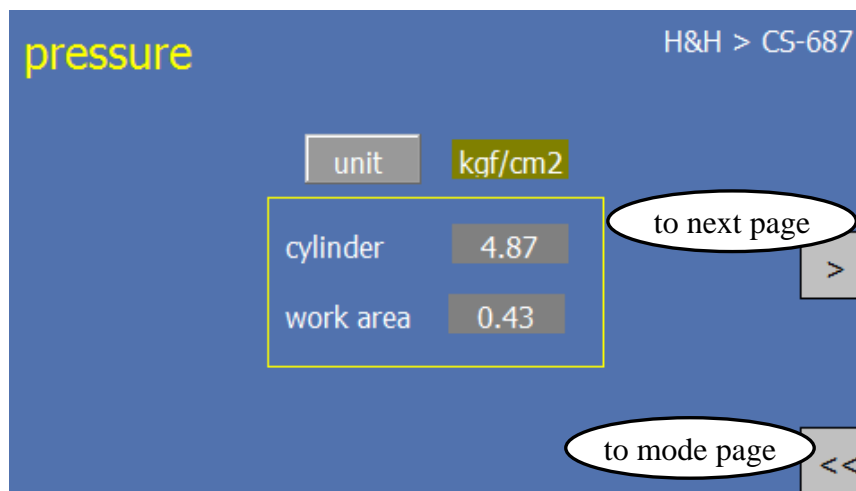

You can change the unit of the pressure press the button “unit”.



## >> Program version

The next page after “pressure” page is “program version” page.

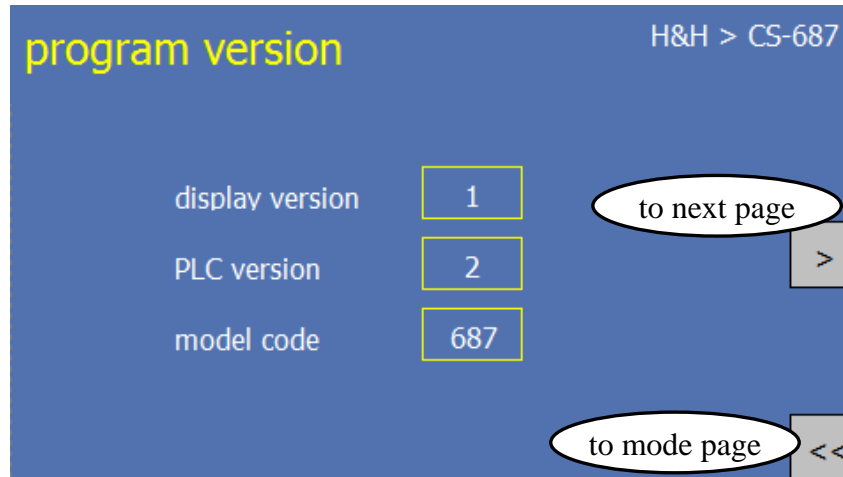

It is an information page for your reference and we can use these data for future maintenance usage.

## >> Language Selection

The next page after “program version” page is “language selection” page.



You can change the language between Chinese and English by push the button #1.

> **Operation and Controls (cont.)**

>> **Supervisor Mode Selection**

When the control key is turned right, you are selected the supervisor mode and the main page will show up a yellow banner “supervisor mode”. All the control keys are the same and can be exchange to use for other similar control series of H&H products. When you push the banner, the display will goes to the supervisor page.

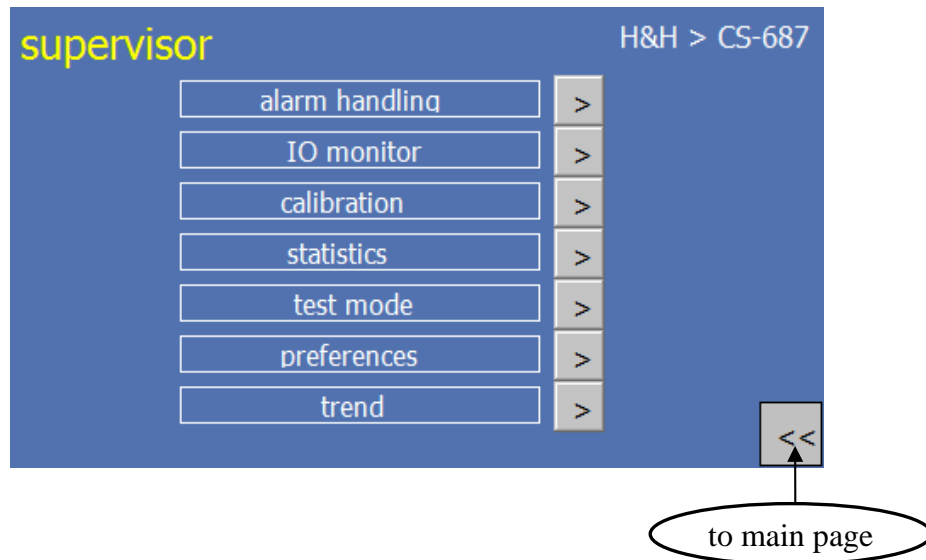

>> **Alarm Handling**

When you press the alarm handling arrow at the supervisor page, the “alarm handling” page will show up. Push the “reset” once to clear the previous alarm.

Below left is showing some alarms and they caused master alarm.

Right one disabled these alarms and the master alarm was lifted.

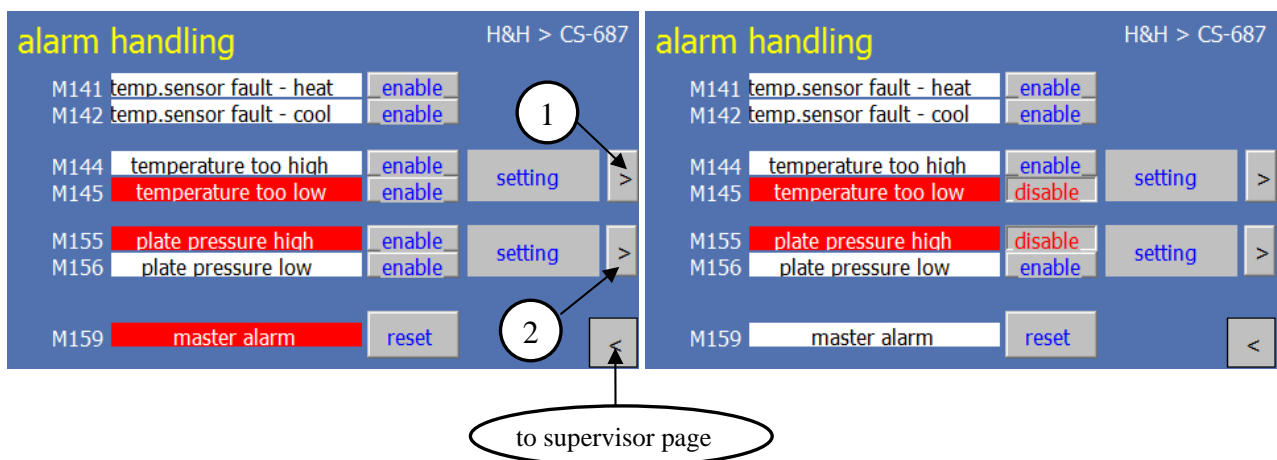

1. goes to temperature monitoring setting page

2. goes to pressure monitoring setting page

You can enable or disable on every row of alarm setting at the right hand side of it. You can also reset the master alarm when the selected alarm is disabled or the fault is fixed.

## > Operation and Controls (cont.)

### >> Temperature Monitoring Setting

When you press the #1 button at the alarm handling page, the “temperature monitoring setting” page will show up.

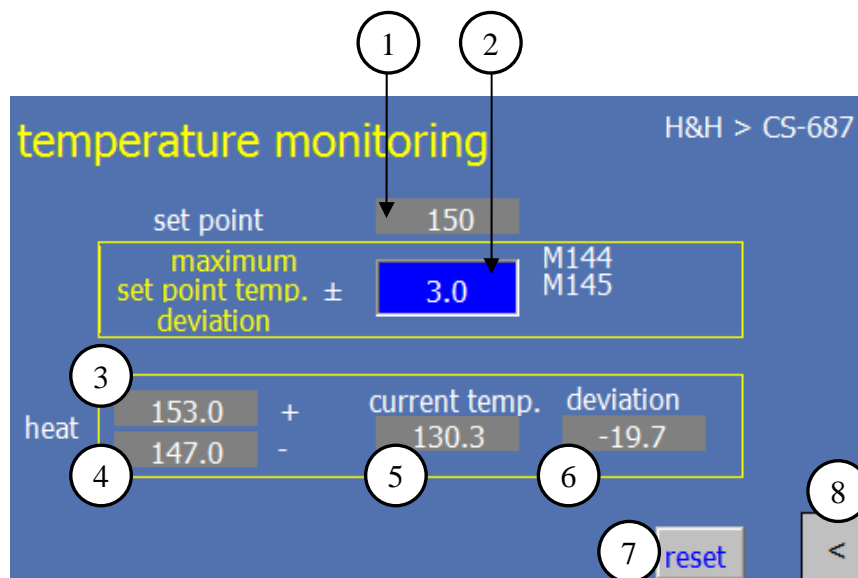

1. set the press temperature
2. set the temperature deviation alarm trigger set point (the range is marked underneath).
3. the maximum permissible hot temperatures
4. the minimum permissible hot temperatures
5. current temperature of the heating plate.
6. display the actual temperature deviation from the set point
7. reset the alarm after the temperature deviation alarm trigger set point is changed.
8. back to alarm handling page.

## > Operation and Controls (cont.)

### >> Pressure Monitoring Setting

When you press the #2 button at the alarm handling page, the “pressure monitoring setting” page will show up.

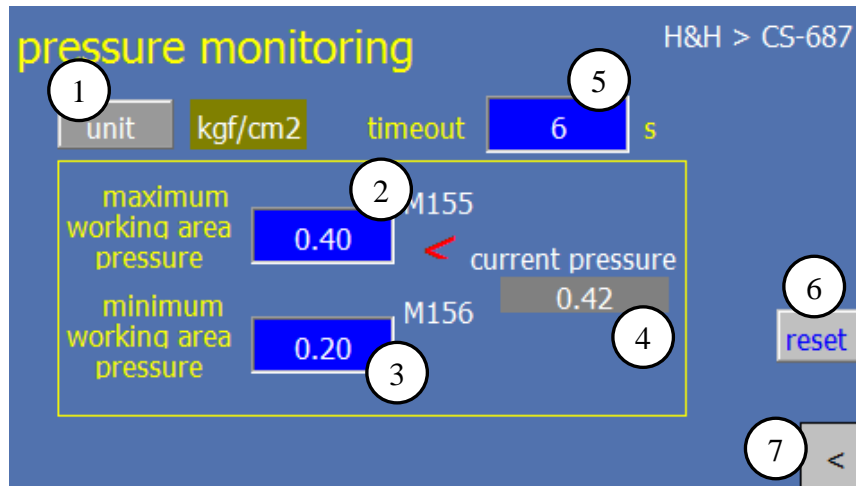

1. pressure unit selector (kgf/cm2, MPa, Bar, Psi).
2. the max working area pressure alarm trigger set point.
3. the min working area pressure alarm trigger set point.
4. display current pressure of working area.
5. set the offset timeout time for the working area pressure alarm to trigger
6. reset the alarm after the pressure deviation alarm trigger set point is changed.
7. back to alarm handling page.

> **Operation and Controls (cont.)**

>> **IO Monitor**

When you press the IO monitor arrow at the supervisor page, the "IO monitor" page will show up.

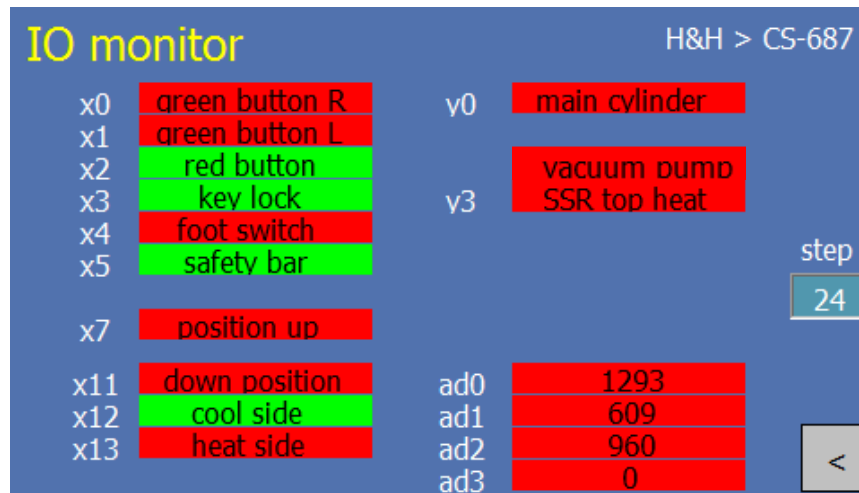

You can observe which limit switch is/are triggered in green, otherwise it will on red color. The step means the progress of the program is going.

>> **Calibration**

When you press the calibration arrow at the supervisor page, the "calibration" page will show up.

Heat, cool corresponding to heating plate and cooling plate respectively.

The temperature correction should be carried out continuously and simultaneously at room temperature (about 50°C) and at 150°C.

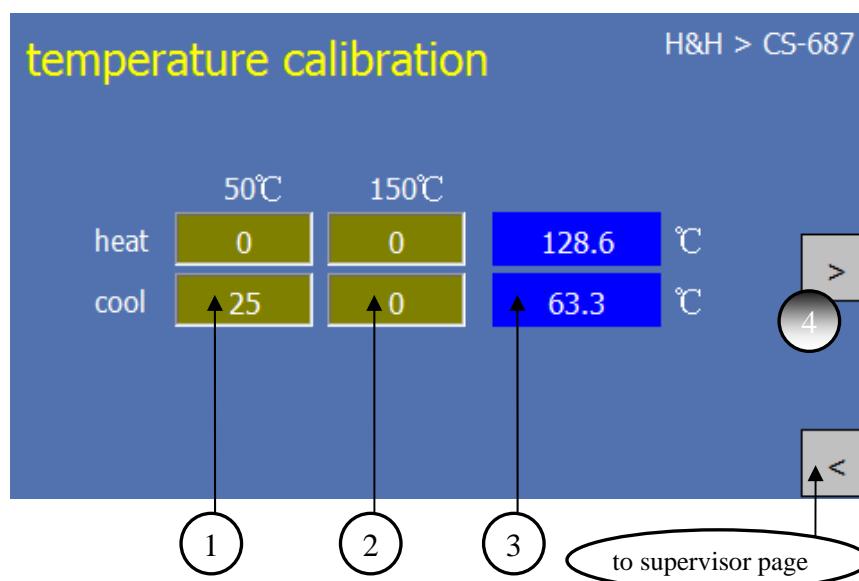

1. set the room temperature (range -100 to 100)
2. set the calibrating curve offset setting number (range -50 to 50)
3. the number in this row will change when the #1 or #2 is changed
4. to angle calibration page

\*For easier precise input, numbers appear here are using 0.1 as the basis unit, input 10=1.0 degree celsius (i.e. 25 at #1 is 2.5 degree celsius).

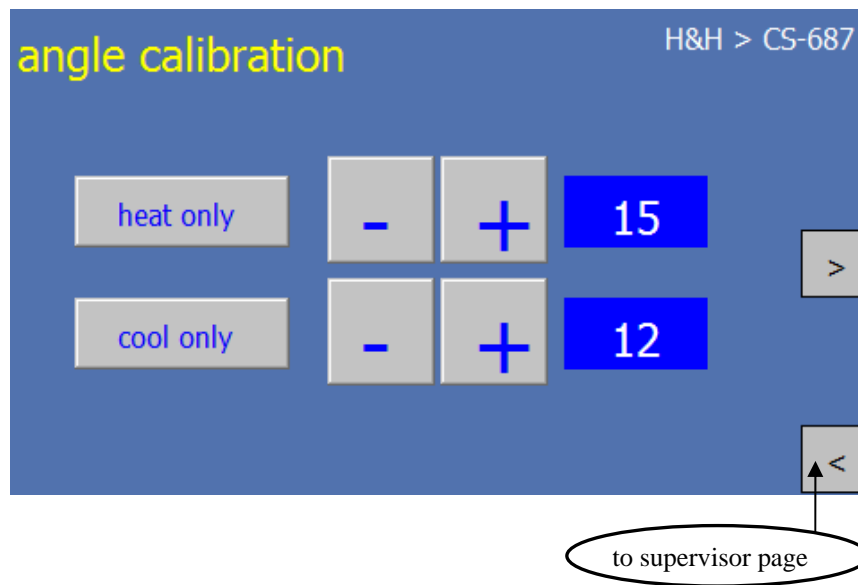

You can calibration the angle of heat side only when the mode was turned to “heat only”.  
You can calibration the angle of cool side only when the mode was turned to “cool only”.

> **Operation and Controls (cont.)**

>> **Statistics**

When you press the statistics arrow at the supervisor page, the “statistics” page will show up.

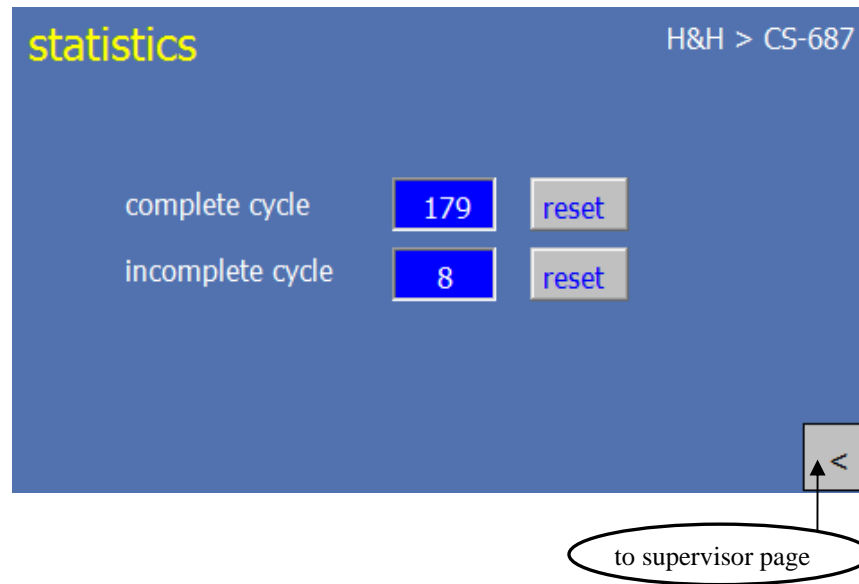

It will show the information of the complete press cycle and incomplete cycle times (triggered by cancel button or safety bar). You can reset both the cycle with the respective reset button. It can prevent the operator from illegally to break the immature cycle for increase the production rate.



**> Operation and Controls (cont.)****>> Test mode**

When you press the test mode arrow at the supervisor page, the “test mode” page will show up.

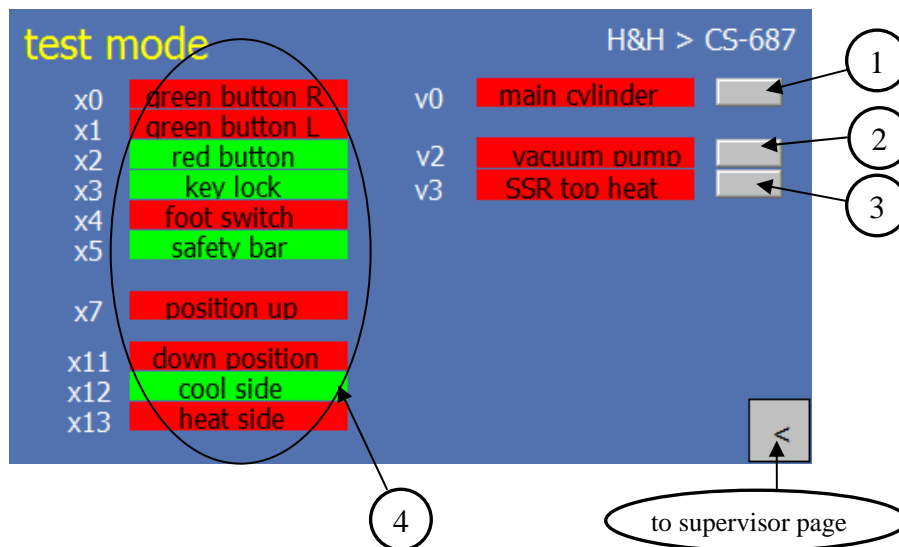

1. press to activate the main cylinder.
2. press to activate the vacuum pump.
3. press to activate the heating plate.
4. feedback of the respective parts (triggered in green while others in red).

> **Operation and Controls (cont.)**

>> **Preferences**

When you press the preferences arrow at the supervisor page, the “preferences” page will show up.

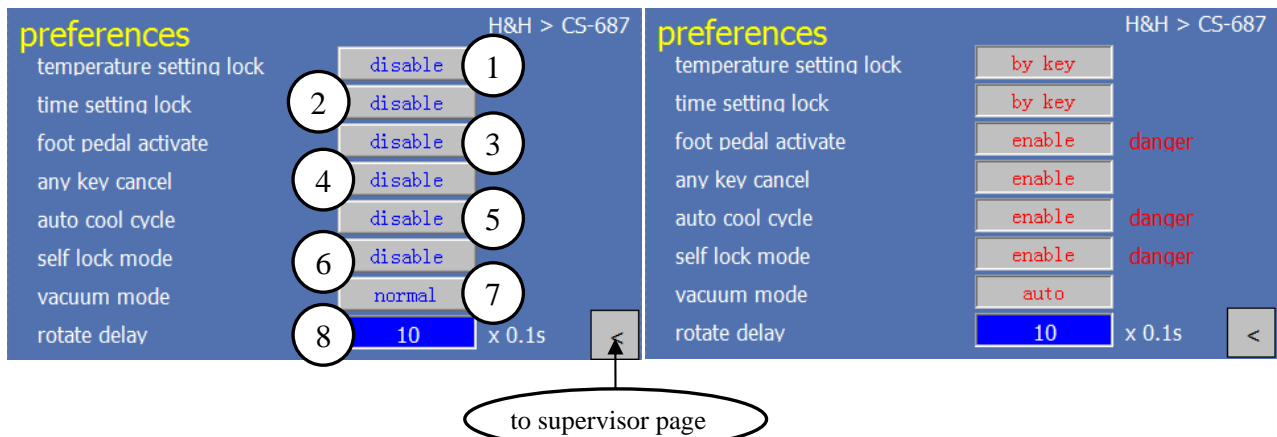

1. press to select the temperature setting lock “off” or “by key”
2. press to select the press time setting lock “off” or “by key”
3. press to enable the foot switch for “press activation”
4. this is a safety device, press to enable the forced cancel of press down motion with any push button
5. if auto cool cycle enable, when the top plate change to cool plate, it will goes down to the working plate automatically.
6. If self lock mode enable, once the start buttons were triggered, the press plate will goes down automatically, no need to press the buttons until the press plate reach the work plate. And there will display danger when self lock mode is enable.
7. select the control of the vacuum pump; in normal mode, the pump will start once the pedal is kicked while it will stop when kicks again. In auto mode, the pump will start once the pedal is kicked and stops when the heat press is down; it will start again when the countdown timer is 3 seconds left. You can stop the pump by kicked the pedal one more time.
8. the press plate will delay to rotate after the press process is finished. this number can setting the delay time, and the unit is ”0.1s”. (10 means 1s)

>> Trend

When you press the trend arrow at the supervisor page, the “trend” page will show up.

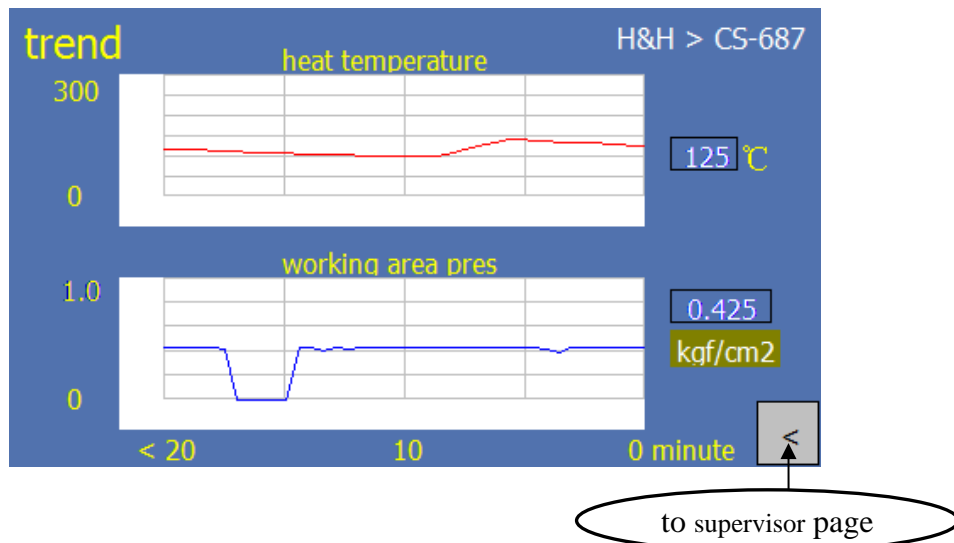

You can check the trend of the working area pressure and temperature in the recent 20 minutes

## > Operation and Controls (cont.)

### >> Manual Control Console

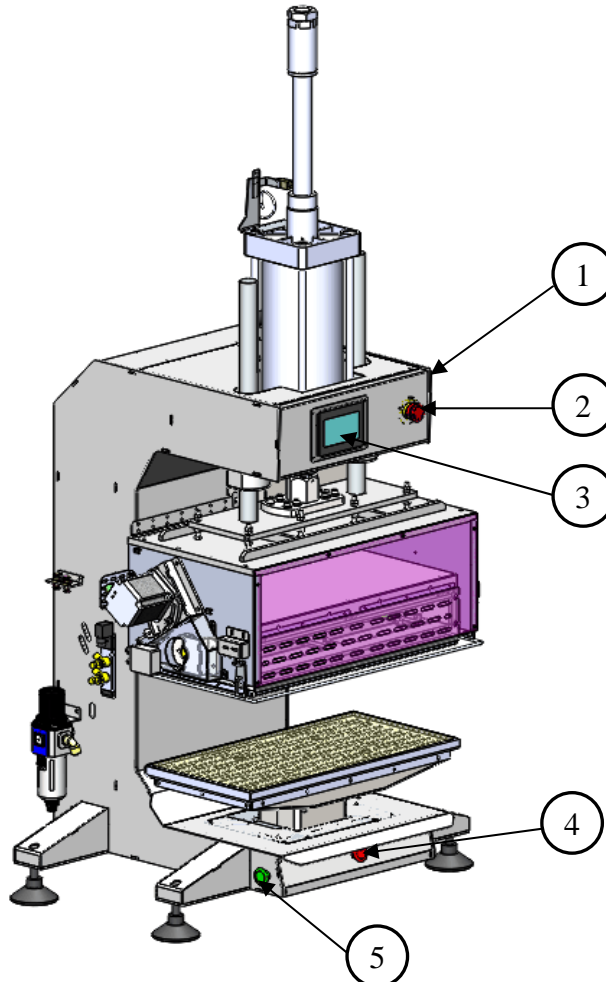

1. operator/supervisor control key switch (turn right for supervisor mode)
2. emergency stop button
3. touch screen control panel
4. stop/cancel button
5. start buttons (in pair)

Remark: start button #5 pair need to press simultaneously, otherwise it will not function.

### >> Press Pressure Adjustment

- A. Turning the knob on the compress air filter regulator to adjust the press pressure.
- B. Turning the press pressure adjusting knot for the cylinder to adjust the press pressure.

> **Precaution when Using Mold**

Some application require a special mold as fixture to position the object correctly, examples are zipper mold or pocket mold. It is essential that the center of mold is position directly under the center of the press, or otherwise the downward pressing force from the main cylinder may induce a rotating force to the rotating head. This may cause damages to the press head and the cylinder and may also affect the overlook of the product due to uneven pressure. In case the mold is required to position off center, a counter balance mold of the same height is necessary to correct the force of the press.

The following illustrations (top view) demonstrate the correct and incorrect method of using mold.

>> **Correct**

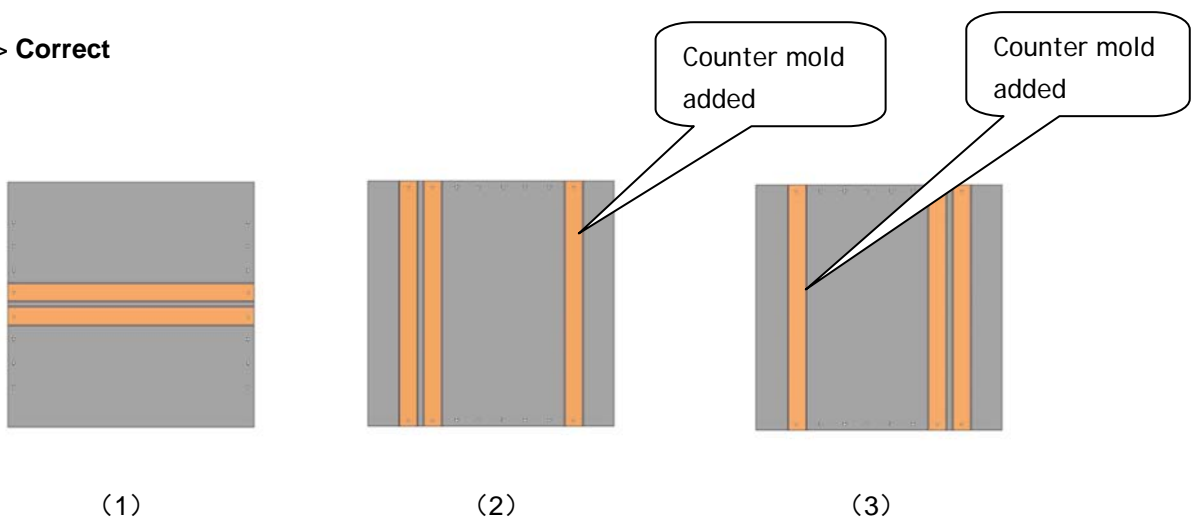

1. Zipper mold is positioned at the center of the working table.
2. Zipper mold is positioned off centered, a counter mold is added at the right hand side of the working table.
3. Zipper mold is positioned off centered, a count mold is added at the left hand side to balance the force

>> **Incorrect**

**X**

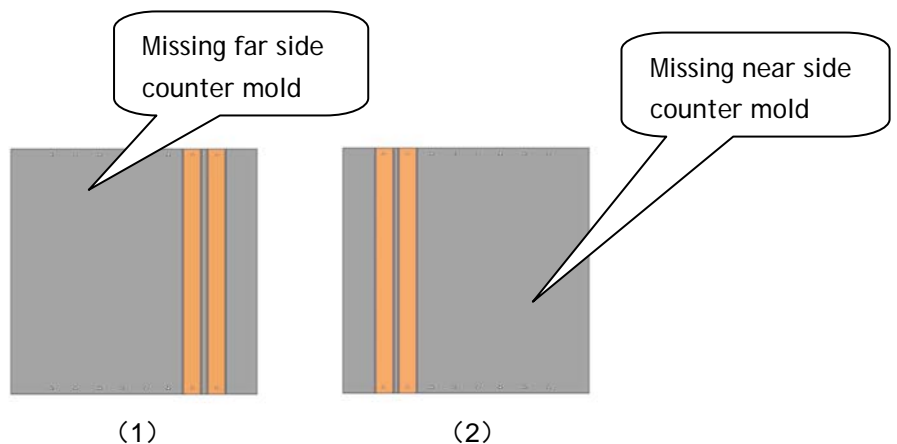

1. Missing left hand side counter mold
2. Missing right hand side counter mold

## > **Cleaning and Maintenance**

### >> **Cleaning the Thermo Plates**

During operation, excess glue or residue may deposit on the surface of the lower silicone rubber and/or the top heat plates. This may deteriorate the outlook of the final product in the coming cycle and cleaning is necessary. To carry out this operation, we suggest you to use a dry piece of towel to wipe off the surface of the heat plate. There is no particular schedule for this type of cleaning, do it whenever required.

### >> **Daily Maintenance**

- Operate the machine a few cycles before use, pay attention to any unusual noise. This may indicate a problem.

### >> **Monthly Maintenance**

- Check the main press side guide rods for smoothness, apply lubrication if needed.
- Inspect the Teflon paper from wear and tear on the heat press, as this may affect the outlook of the finished product. Replace with a new one if necessary.

> **Trouble Shooting**

Problem	Cause	Solution
Display not light up Whole machine not working	Power supply not connected	Plug in a suitable power supply
	Power plug not secure	Try to plug in socket again
	Overloaded or tripped of circuit breaker	Check the problem and reset breakers
Heat plate not heating up	Heater not enabled	Press the <b>heat</b> button once
	Preset temperature lower than room temperature	Change preset temperature above room temperature
Excess noise and vibration during operation	Floor is not level or wheels are not locked	Reposition machine to a level and solid floor

> Appendix A . Pneumatic Scheme

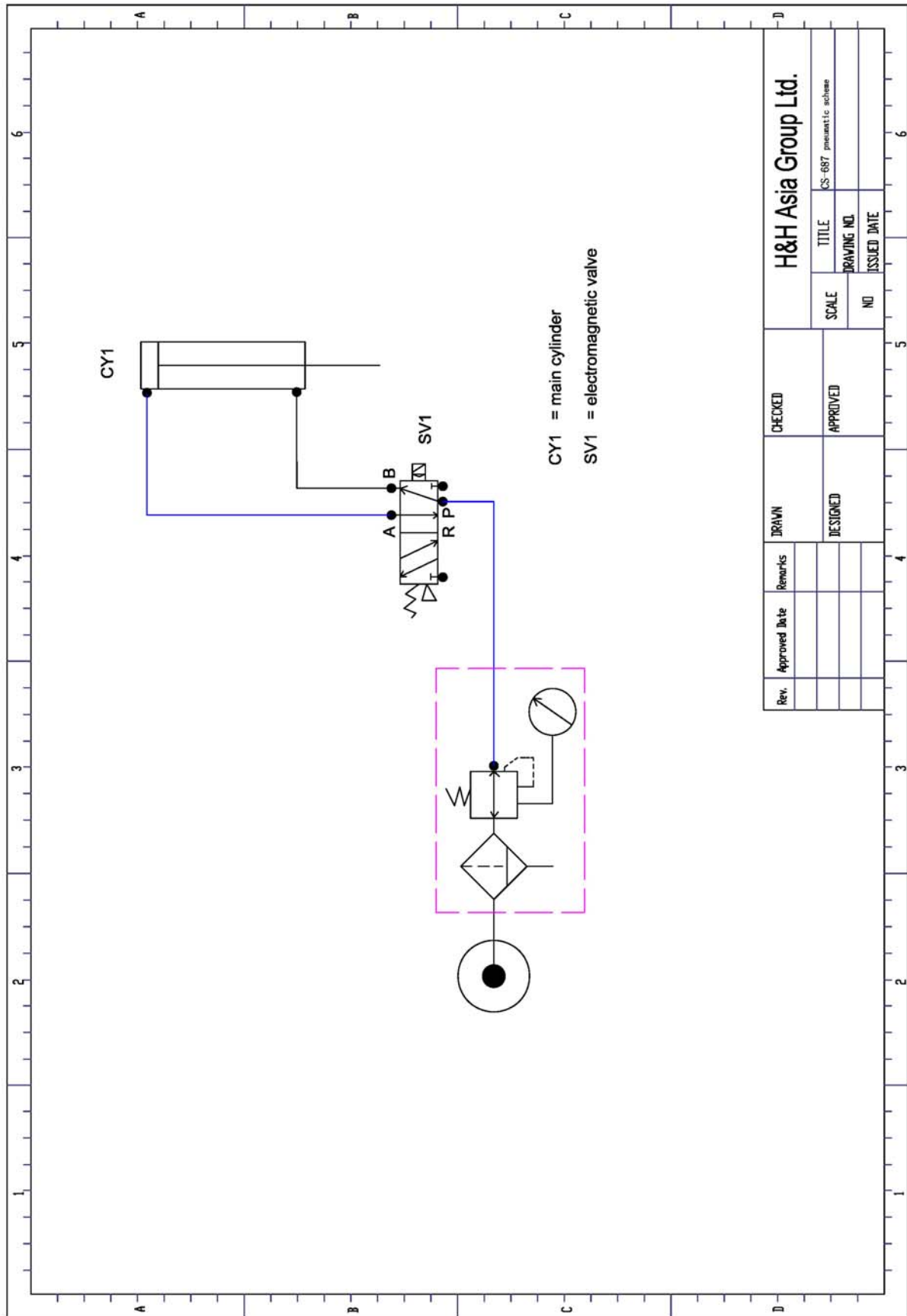

Rev.	Approved Date	Remarks	DRAWN	CHECKED	H&H Asia Group Ltd.		
			DESIGNED	APPROVED	SCALE	TITLE	CS-687 pneumatic scheme
					NO	DRAWING NO	
						ISSUED DATE	



> Appendix B . Wiring Scheme

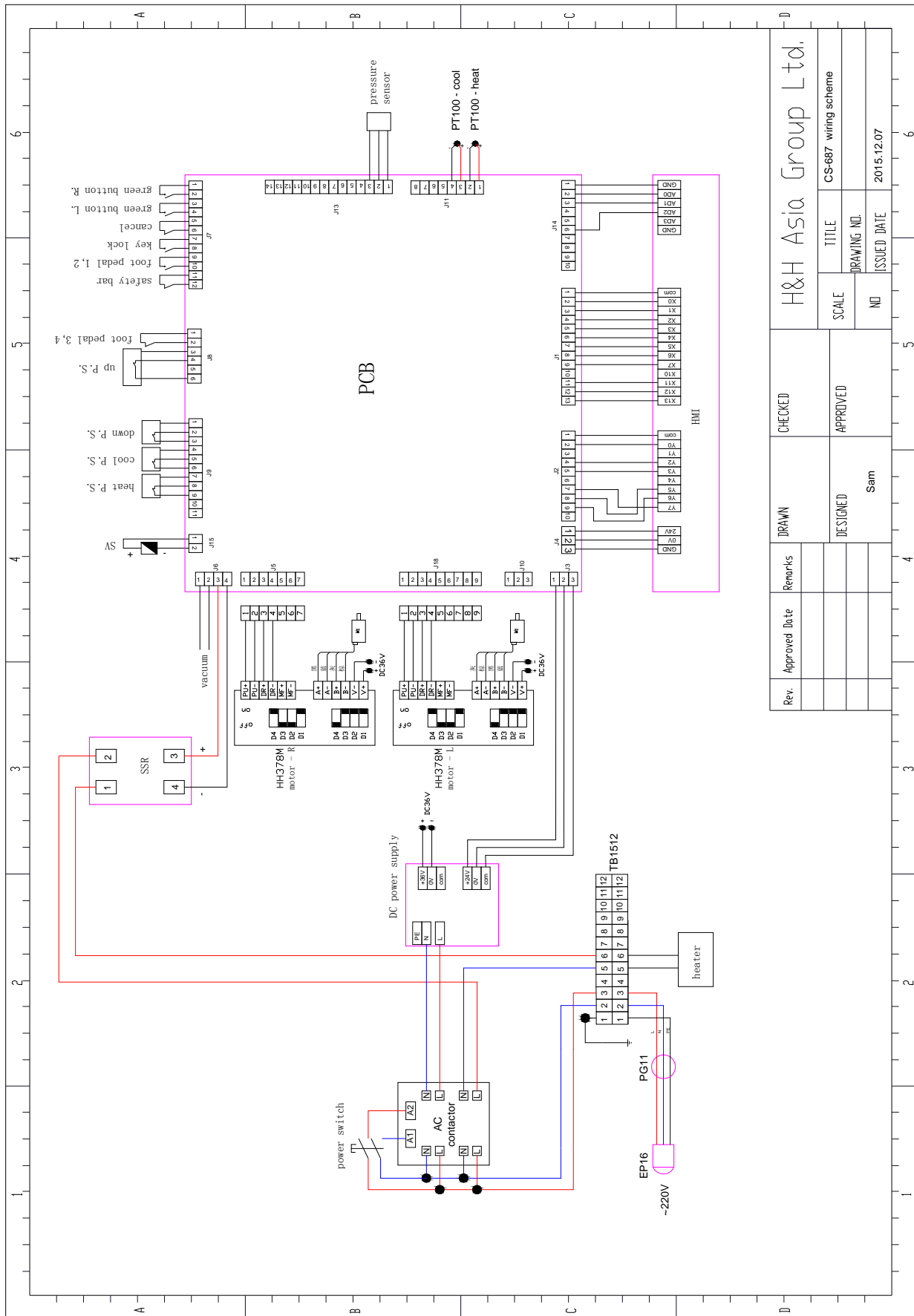

Rev.	Approved Date	Remarks	DRAWN	CHECKED	H&H Asia Group Ltd.		
			DESIGNED	APPROVED	SCALE	TITLE	CS-687 wiring scheme
			Sam		NO	DRAWING NO.	ISSUED DATE
							2015.12.07